



Liquid Cooled Heads

Installation Guide

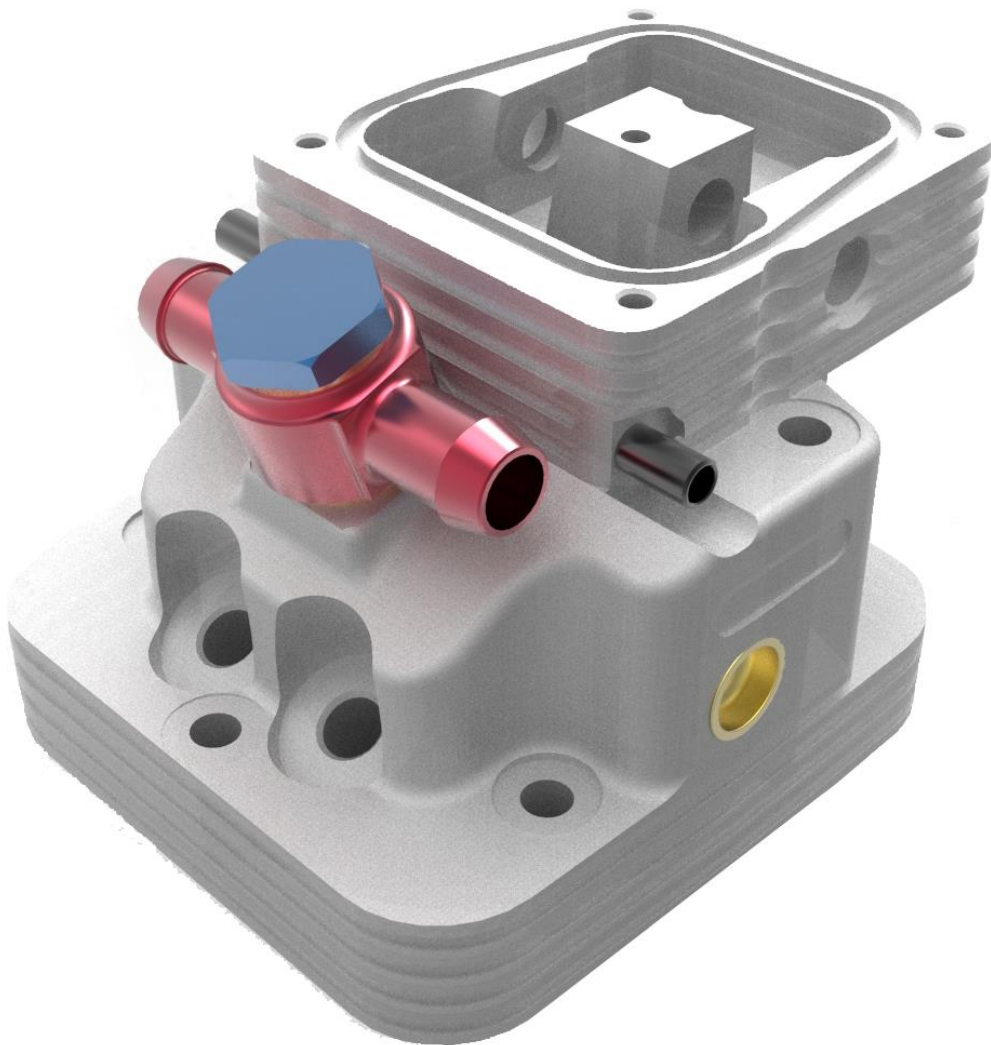

Table of Contents

1. Kit Component List.....	3
1.1 Contents of Rotec Aerosport Liquid Cooled Heads (LCH) Kits	3
1.2 Contents of Rotec Aerosport LCH Piping Kit	5
2. Preparation	6
2.1 Parts to be Re-used per Head	6
2.2 Tools & Resources	7
2.3 Preparation work	8
3. Installation Procedure	9
4. Recommended Pump Sizes.....	12
5. Recommended Radiator Size	13
6. Recommended Radiator Mounting Locations.....	14
7. Water Cooling Circuit	17
8. Electrical Recommendations.....	22
9. Installation Tips	24

1. Kit Component List

1.1 Contents of Rotec Aerosport Liquid Cooled Heads (LCH) Kits*

Item	Image	Jabiru 2200 4 Cylinder	Jabiru 3300 6 Cylinder	Jabiru 5100 8 Cylinder
Rotec Aerosport Liquid Cooled Heads		4	6	8
Replacement head bolts (5/16" - 24 x 3.5" SHCS)		8	12	16
Replacement head bolts (5/16" - 24 x 1.5" SHCS)		4	6	8
Head bolt washers (5/16" (M8) x 17.00 x 2.0)		24	36	48
Head bolt access port grub screws (1/8" BSPT x 3/8")		4	6	8
Single connection coolant outlets		2	2	2
Dual connection coolant outlets		2	4	6
Copper washers (20 x 24 x 1.5)		8	12	16
Coolant inlet tubes**		4	6	8
Coolant inlet tubes bolts (+M6 internal lock washers) (1/4" - 20 x 1/2")		4	6	8
Banjo bolts (one with CHT hole)		4	6	8

*All Rotec Aerosport Liquid Cooled Heads come only with parts needed to accommodate original components of the Jabiru engine. Only necessary replacement parts have been provided in order to keep the price as low as possible.

Liquid Cooled Heads come standard fitted with:

- 2x valve guides
- 2x valve seats
- 2x pushrod tube internal circlips 20 mm x 1 mm
- 2x welch plugs Ø18 mm
- 1x coolant inlet o-ring 16 mm x 3 mm
- 2x pushrod tube o-ring 16 mm x 3 mm
- Rocker box oil port depending on engine variation.

3 new head bolts are provided per head. The 2 longer type will replace the two standard longer head bolts from the original head, and the shorter type will replace the bolt at the rear, near the water jacket inlet/outlet.

We supply you with enough head bolt washers for all head bolts, this is to protect our cast head surface.







**Number indicated on tube corresponds to Cylinder number. Some tubes have different geometry to clear the intake pipes. See page 9 for cylinder #'s.

1.2 Contents of Rotec Aerosport LCH Piping Kit

Engine Piping Kit Type	Image	Jabiru 2200 4 Cylinder	Jabiru 3300 6 Cylinder	Jabiru 5100 8 Cylinder
5/16" ID rubber hose, 47 mm long		2	4	6
5/8" ID rubber pipes, single bend, 1270 mm long		4	6	8
35 mm ID pump connection pipe		0	1	1
25 mm outlet hose spring clamps (apply constant tension)		16	24	32
Filler neck with radiator cap		1	1	1

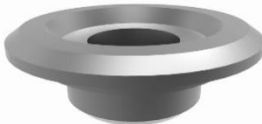
2. Preparation

2.1 Parts to be Re-used per Head*

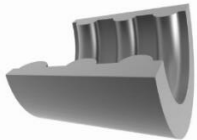
Part	Image	Number per Head
Rocker arms		2
Valve springs (inner and outer)**		2-4**
Valve retainers		2
Rocker pin		1
Intake valve		1
Exhaust valve		1
Split collets		4 pcs (2 sets)
Rocker cover bolts		4
Cylinder head bolts***		3

*If replacement part is desired please contact Jabiru for OEM parts.

**Some engines have only outer valve springs (2 per head), whereas others have 2 outer valve springs and 2 inner valve springs per head.

***Front 3 bolts to be re-used (bolt numbers #1, #2, #6 as per page 10). 2 long side bolts and the 1 rear bolt to be replaced with the ones provided in this kit (bolt numbers #3, #4, #5 as per page 10).

2.2 Tools & Resources

Tools & Resources Required

- 1/4" Allen Key
- 3/16" Allen Key
- 7/32" Allen Key
- 1/2" Socket Spanner
- Long Nose Pliers
- Flat Head screwdriver
- Anaerobic adhesive ([Loctite 262](#) or substitute)
- Anaerobic adhesive primer ([Loctite 7471](#) or substitute)
- Oil rags

Optional Tools

- 5/16" UNF Bottoming Tap
- Small round file / Dremel

2.3 Preparation work

Note: It is recommended that you read through the entire manual before you begin the conversion process. This way you can plan your installation and avoid reverting back to previous steps if mistakes are made.

- Some engines have corrosion and dirt in the cylinder threads after years in the field. With the air-cooled heads removed, the Jabiru cylinders can be tapped using a 5/16" UNF tap. Tapping the cylinder threads will ensure the head bolts will have no issues when being torqued. Ensure that no swarf is left in the combustion chamber during this tapping process.
- Standard Jabiru valves fit Rotec heads. If desired new valves can be used, although this is only necessary if they require replacing. Please contact Jabiru for OEM replacement parts.
- The LCH is designed to fit all Jabiru exhaust systems including: the earlier gasket seat, conical tapered seat, two and three bolt flanges. Fitting the LCH to the two bolt flange is an identical process as three bolt flange only the third thread is not used.

Design changes of the air cooled head over the years have resulted in different rocker cover bolt patterns. Some customers will find their original rocker covers do not match the LCH rocker cover bolt pattern. This can be solved using a small file. The bolt holes on the original rocker covers can be filed out to match the LCH bolt pattern. This has no effect on the sealing potential of the rocker cover.

3. Installation Procedure

Prior to the installation you must prepare your engine by removing the old heads and ensuring that the pistons and cylinder surfaces are clean and in good condition. After the engine has been prepped, the LCH installation can proceed.

1. Identify the number stamped onto each liquid cooled head. The number should be matched with the cylinder denomination with your stock cylinders. Head numbers only set the position of the rocker oil pipes, as some heads have blanked off oilers while others have the oil port nipples. These are installed accordingly depending on the specification of mechanical or hydraulic lifters prior to purchase.

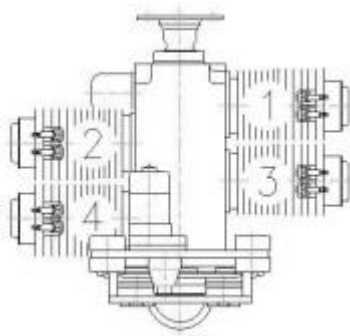

Jabiru 2200

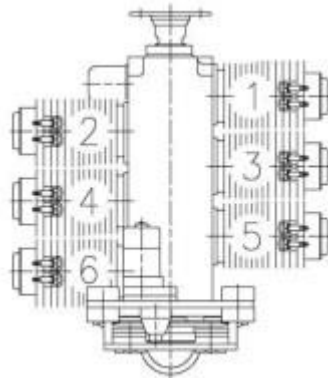

Jabiru 3300

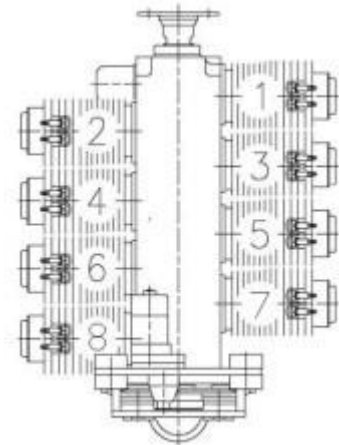

Jabiru 5100

2. While the Liquid Cooled Heads are off the engine, install valves, springs and retainers and per standard Jabiru procedure. **Do not** install the rockers as push rods need to be installed while heads are on the engine.
3. Introduce the Liquid Cooled Heads to each cylinder with the push rod tubes in position. You will need to replace head bolts #3 and #5 with the head bolts provided by Rotec. Reuse all other existing Jabiru head bolts, unless provided new ones. Be sure to install the 2 mm thick head bolt washers provided on ALL head bolts. Do not use the Jabiru washers as they are not the required thickness.

4. Refer to figure 3.1 and tighten head bolts in a procedural manner intermittently, applying maximum specified torque to each bolt at the end of the exercise. Tighten the head bolts to 18 lb.ft (24.4 N.m). Follow the standard cylinder head tightening procedure using a 1/4" Allen Key. #1 - #5 - #3 - #6 - #2 - #4.

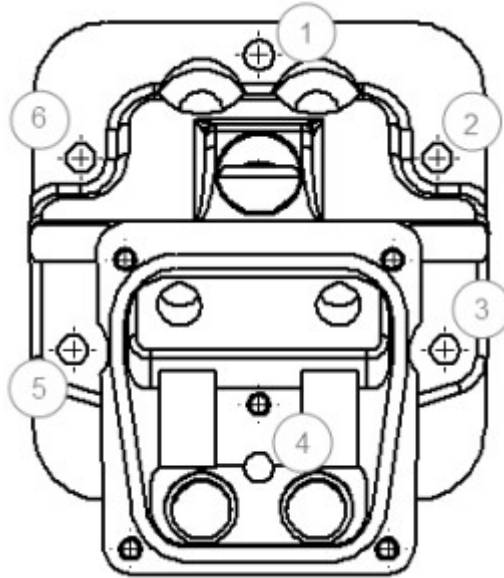

Figure 3.1: Cylinder head bolt numbers.

Note: 6 and 8 cylinder engine installations will need to keep in mind the order heads are installed. For examples if heads #2, #4 and #6 are installed onto the cylinders, you will not be able to access the rocker pin hole on cylinder #4 to install the rocker arms.

5. Once you have all the heads tightened as specified you must seal access port for cylinder bolt #4. Using a 3/16" Allen Key tighten the 1/8" BSPT grub screws provided to approximately 10 lb.ft (13.6 N.m).
6. With the push rod tubes installed, introduce the pushrods.

Warning: For hydraulic lifter engines make sure the push rods are correctly positioned as per Jabiru installation manual.

7. On each head install the original Jabiru rocker pin and rocker arms. Once the rocker shaft is installed you can push each end of the shaft out just enough to expose the o-ring groove. Place the 8 x 2 mm o-ring on

one end, apply oil and using a rotating motion twist the shaft while pushing the o-ring back inside the bore. Be very careful not to shave the o-ring on entry as oil tight seal will be lost. This is why a rotating motion with oil is used. Repeat the process on the other end of the shaft. You should now have an o-ring sealing both end of the rocker shaft.



8. Reinstall the original 1/4" - 20 Allen bolt that prevents the rocker pin from floating out during operation. You will need to rotate the shaft such that the bolt is concentric with the scallop in the centre of the rocker shaft.
9. Set the valve clearances as per the Jabiru manual.
10. Install the 6 water inlet pipes to the bottom sides of the 6 heads.

Note: Each water inlet pipes has a stamped number that must coincide with its matching cylinder number.

Apply some lubricant (WD40 or light oil) to help the entry of the inlet manifold pipes. There is an embedded o-ring inside the port. Lubrication is to avoid damage to the o-ring upon entry.

Use the provided 1/4" - 20 x 1/2" bolts and star washers supplied to secure the coolant inlet manifold pipes to their respective head.

4. Recommended Pump Sizes

Model	Image	Recommendation
<p>15 L/min or 25 L/min Electric Booster Pump - EBP15 / EBP25</p>		<p>Recommended only for installations where radiator performance is exceptional, (for example under-wing mounted radiator), and where fiberglass ducts are retained.</p>
<p>80 L/min Electric Pump - EWP80</p>		<p>Recommended for almost all Jabiru 2200 and 3300 installations. If the EWP80 pump is used, the original Jabiru fiberglass ducts are not required and can be completely deleted from the installation.</p>
<p>115 L/min Electric Pump - EWP115</p>		<p>The EWP115 pump is recommended for all Jabiru 5100 installations.</p>

5. Recommended Radiator Size

Any 2 port radiator can be used. It is advised that the radiator does not have an integrated filler cap, unless the radiator is mounted at the highest position of the system. Otherwise an isolated filler cap will be mounted above the water level. Most small motorcycle radiators are 350 mm x 250 mm large and do not have filler caps, making them ideal for your installation.

Radiator outlet fitting sizes depend on the pump being used. If an EBP15 or EBP25 is used, a Ø 3/4" (19 mm) radiator outlet is recommended. If an EWP80 is used, a Ø 1 - 3/8" (35 mm) is recommended – although the pump can be adapted to fit sizes from Ø 35 mm - 45 mm, or 19/26/30 mm (sold separately). If an EWP115 is used a Ø 1 - 1/2" (38 mm) is recommended, although the pump can be adapted to fit sizes from Ø 1 - 1/2" to 2".

Assuming the supplied filler cap will be used, the recommended radiator inlet size is Ø 19-22 mm.

6. Recommended Radiator Mounting Locations

On a Jabiru aircraft radiators are successfully mounted at the bottom of the engine, in front of the standard Jabiru exhaust. This is the most convenient place to mount your radiator. Dual radiators can also be used if desired.



Figure 6.1: Jabiru SP 6 with the radiator mounted in front of the engine.

Observe figure 6.1 for an example of a Jabiru SP 6 with the radiator mounted in front of the engine. Using a new lower engine cowl, air is able to enter the mouth, flow into the bottom section, then pass over the installed radiator, and exit after passing the exhaust system.



Figure 6.2: Jabiru SP 6 with the radiator plenum exposed and cowl removed

With the cowl removed, the radiator plenum is exposed, displayed in figure 6.2. This particular aircraft has an oil cooler also utilising the new engine cowl mouth.

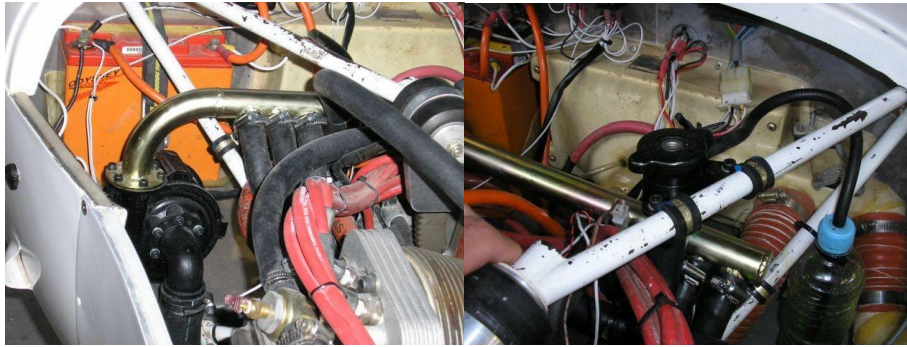

Figure 6.3: Jabiru SP 6 with all heads connected to pump via common rail

Common rail connecting the pump to all the heads. Filler cap mounted above the water level.

Note: It is recommended that the water pump is mounted at a lower point than the cylinder heads. This ensures that the water pump will be submerged in fluid at all times. If the water pump is pumping air only, the pump motor could fail.

For other aircraft you may choose to mount your radiator under the wing, shown in figure 6.4.



Figure 6.4: Radiator mounted under wing.

The radiator mounted under the wing allows for better cooling performance, while creating some drag. In figure 6.5 a 15 L/min booster pump has been used instead of the recommended 80 L/min pump, because adequate cooling is provided with the exceptional radiator performance.



Figure 6.5: Installation of a 15 L/min booster pump

Note: A heater tank is highly recommended for installations where the radiator is at a lower position than the cylinder heads. This ensures that if any air is in the system, it will not be trapped within the cylinder heads causing overheating. For installations where the radiator is mounted at a higher position than the cylinder heads, only a filler neck is appropriate.

7. Water Cooling Circuit

Assuming the inclusion of Rotec Aerosport LCH Piping Kit, filler neck, and cross connection.

1. The water pump draws coolant from the lowest point of the radiator. One method to supply cold water from the pump to the heads is with a common rail. A common rail has the same number of ports, as the engine has cylinders. These ports have individual $\frac{5}{8}$ " rubber hoses connected to each individual head.
- 2.

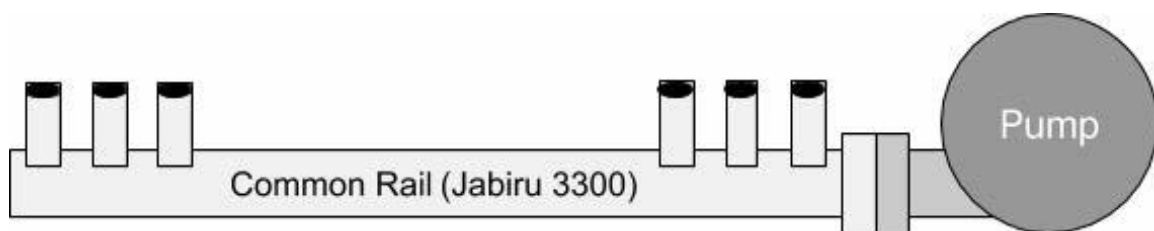

Figure 7.1: Inlet manifold (common rail). At one end of the coolant inlet rail ports feed the left hand bank of heads. Ports at the other end feed the right hand bank of heads.

Alternatively a series of $\frac{5}{8}$ " tee and cross barbs can be used to appropriately plumb the [water in](#) side of the heads to the pump, (refer to figure 7.6).

2. The water exits the heads (water out), via the individual banjo fittings located at the top of each head. Each bank of heads should have their banjos linked in series, using off-cuts from the $\frac{5}{8}$ " rubber hoses provided.

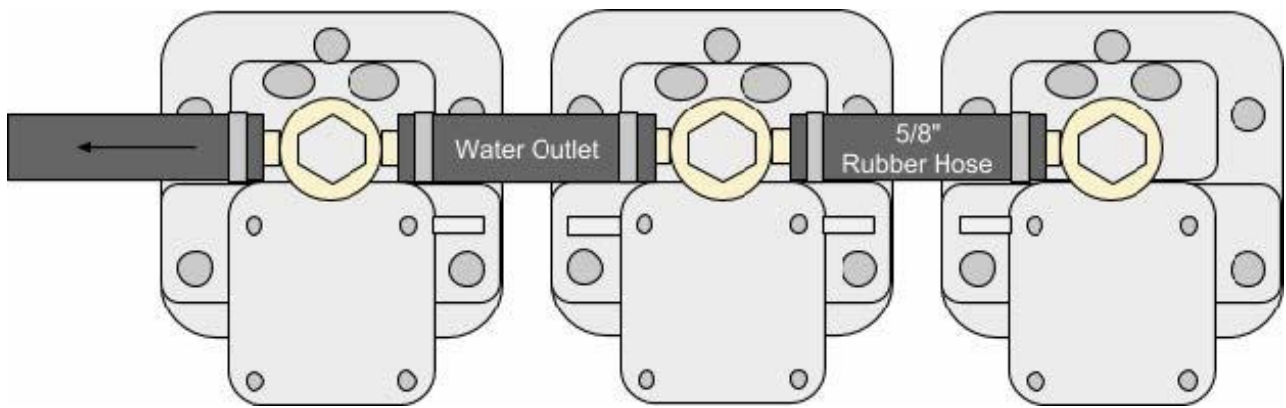

Figure 7.2: Water outlet of heads connected in series.

Use the 25 mm outlet hose clamps provided to seal connections. A single hose will trail off the end of each bank of cylinders. You must use anti-seize on the aluminum banjo fittings to avoid galling.

Tip: When purging the system for air, hose clamps do not need to be loosened.

- The two (hot) outlet hoses should converge as one and intersect with the remote filler neck and radiator. A cross section will need to be used in order to connect them. The two bank of heads connect via $\frac{5}{8}$ " fittings, and the filler neck to the radiator connect via $\frac{3}{4}$ " connections.

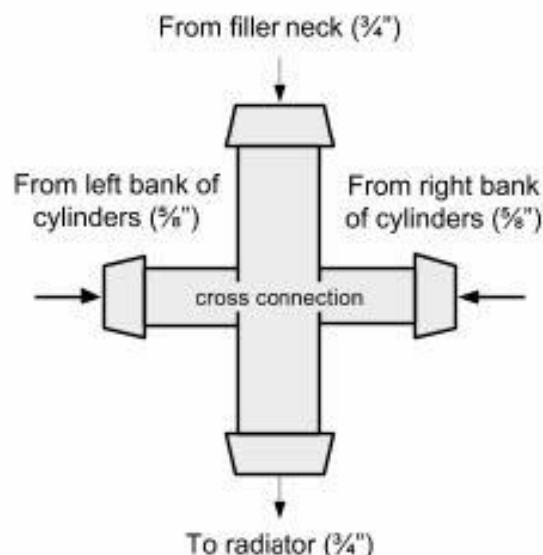

Figure 7.3: Cross connection fitting.

4. A typical motor bike filler neck and cap is ideal for this type of cooling system. The filler neck must be placed at the highest point in the system, (unless a radiator with filler neck is at the highest point). This will allow to system to be filled when the engine is stationary, and allow for any air to be easily purged from the system.

It is recommended that the radiator cap is of the pressurized variety, and the filler neck will have a pressurized overflow port to accommodate that. This port should have a $\frac{1}{4}$ " hose or similar connected and routed to an overflow bottle. A filler tank is recommend instead of a filler neck on installations where the radiator is lower than the position of the heads.

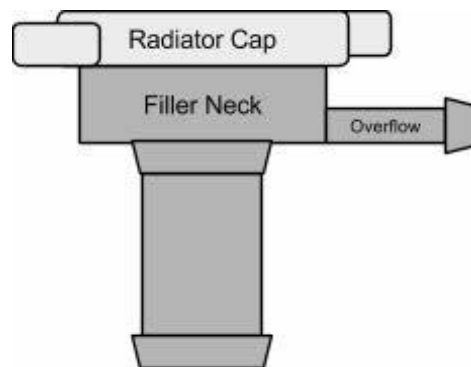

Figure 7.4: Filler neck with radiator cap and overflow fitting.

5. The $\frac{1}{4}$ " hose should extend all the way down to the base of bottle. When the system cools down and contracts, some of the water in the overflow bottle will be sucked back from the bottle into the cooling system. For this reason the overflow bottle is to be roughly half full of water.
6. The overflow bottle itself must have a hose connected to the highest point of the bottle. This hose will be routed down along the aircraft firewall, to a location that can allow water to overflow.
7. Make sure all connections in the system are properly clamped so that no air can enter the system, degrading cooling performance and causing potential problems.

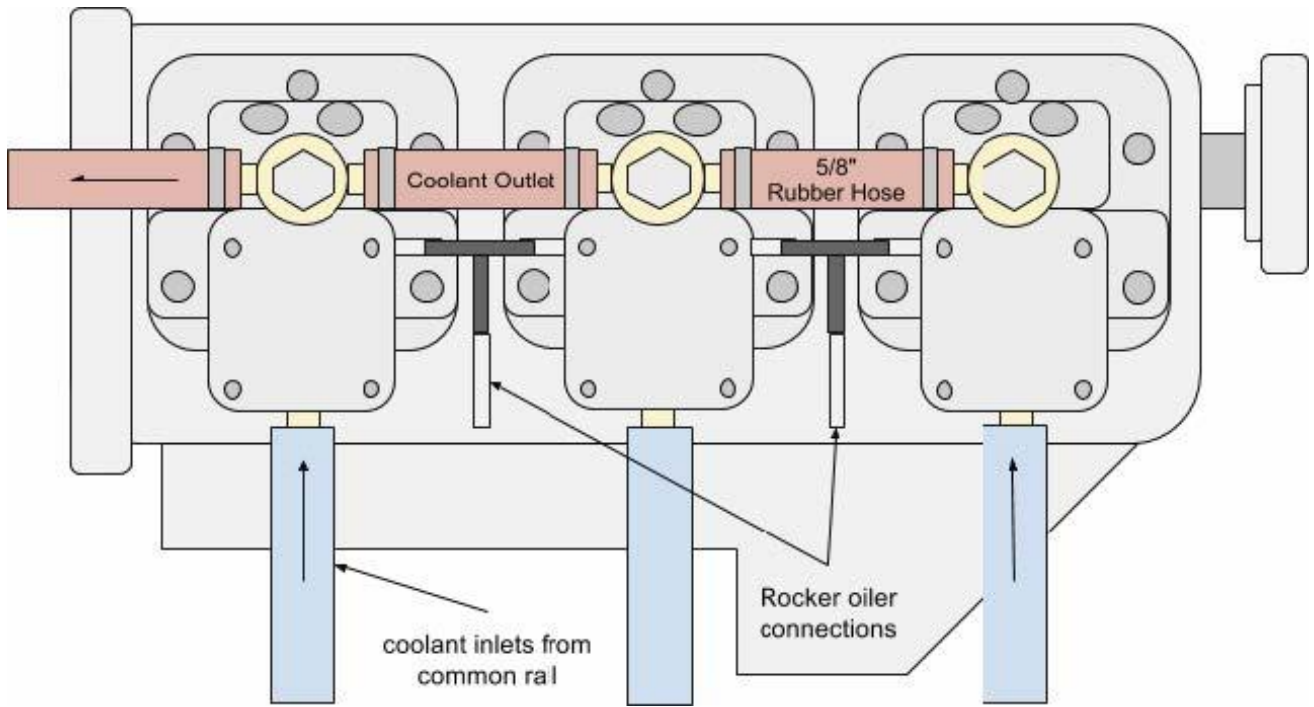

Figure 7.5: Left bank of cylinders shown only.

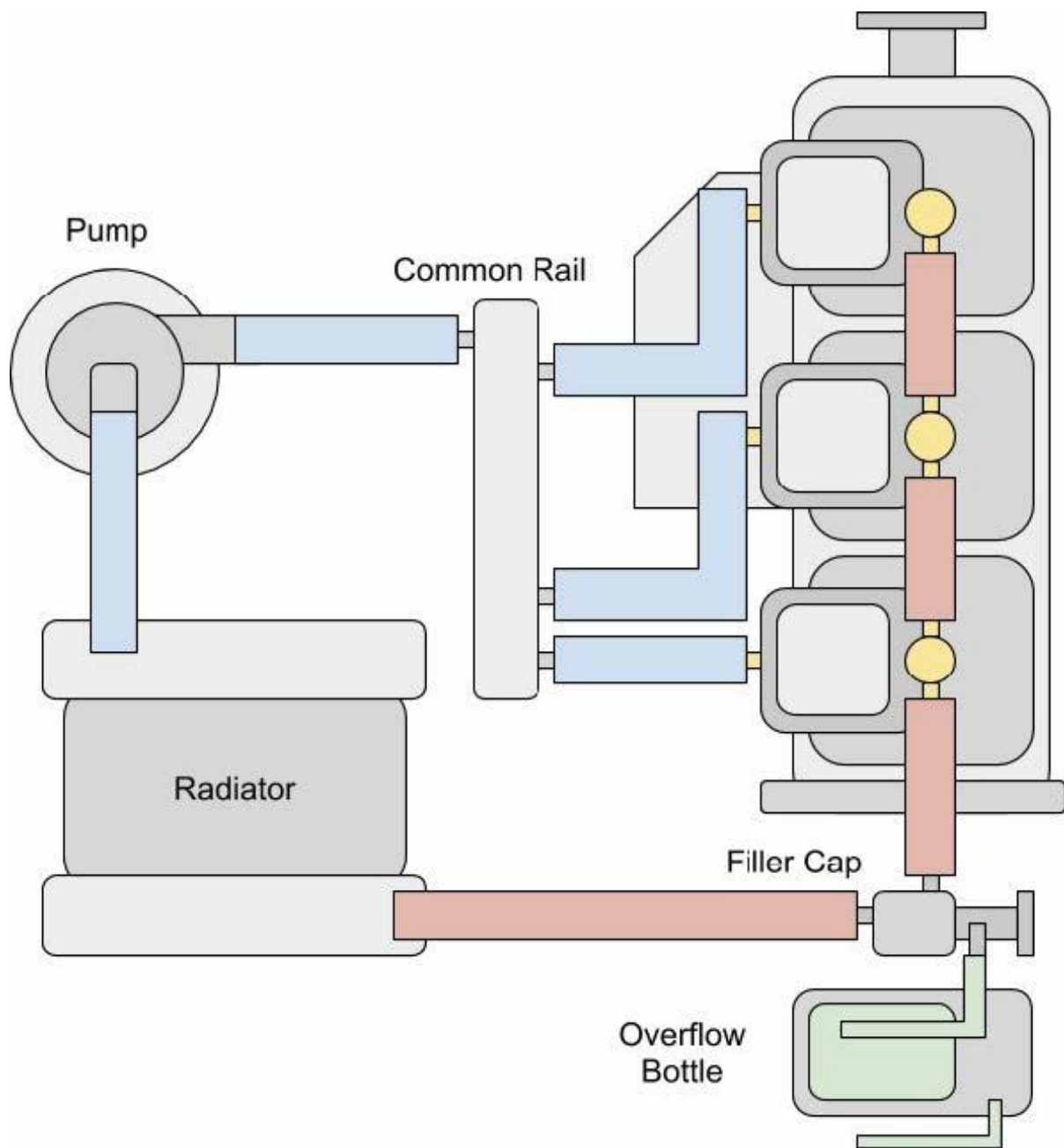

Figure 7.6: Basic cooling system schematic. Note that left bank of cylinders shown only.

8. Electrical Recommendations

1. 0-120°C (or 0-250°F depending on preferred unit of measurement) water temperature gauge must be installed on the instrument panel. This will be the primary indicator of head temperature. We highly recommend for testing and calibration purposes that the gauge is powered and connected to the probe. Dunk the probe into boiling water. This is to confirm that the probe measures exactly 100°C (212°F), as water boils at 100°C (at standard sea level pressure). Some gauges can vary in accuracy. A mark can be placed on the dial face to indicate the exact 100°C position (or 212°F depending on gauge).
2. The temperature probe is installed into the single drilled and tapped (1/8" NPT) aluminum banjo bolt, which is expected to be installed in one of the rear most cylinders. You will only need one temperature probe.

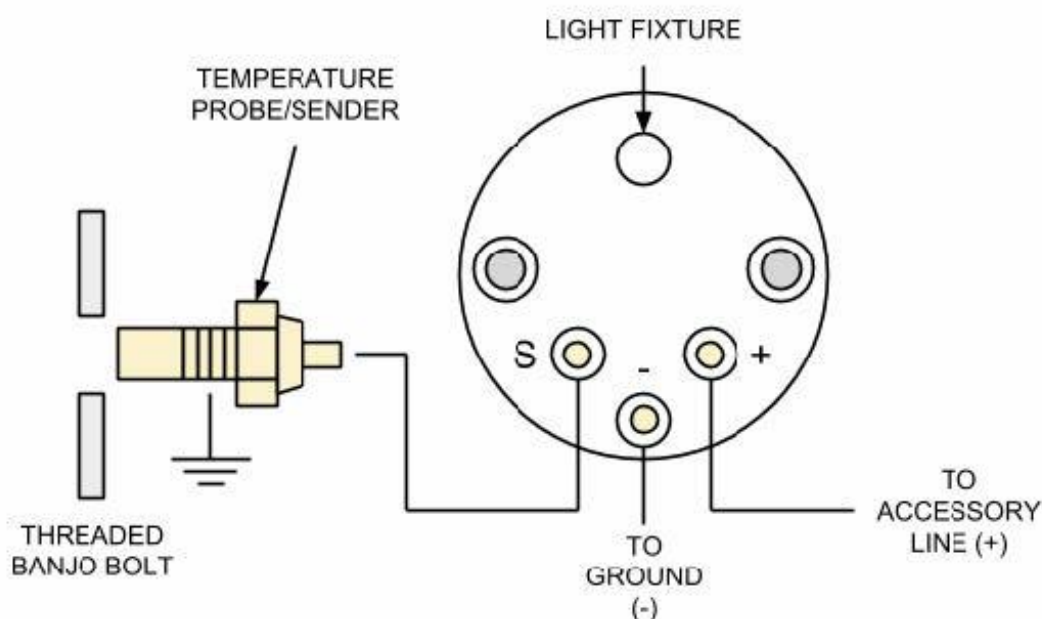

Figure 8.1: Water temperature gauge circuit, (terminals may vary depending on model). Temperature sender grounds to threaded banjo bolt.

3. The water pump draws around 2-3 amps, choose an appropriate breaker or fuse. Although give the fuse margin so the circuit does not fail due to the protection being inadequate. We recommend a 10-15 amp fuse. The

40 amp relay is to be wired as per the wiring diagram supplied with the pump kit. We recommend to include a water pump ON / OFF switch next to the temperature gauge. The switch can be left off for start-up and employed after warm-up, or sometime shortly after start-up. This gives maximum control to the pilot.

Thermostat control could be achieved by installing a simple pilot operated mechanic flow valve in series with the water circuit – basically just a tap. Another option is to install the Davies Craig speed controller. This device controls the RPM of the water pump to maintain a desired temperature. In the advent of speed control failure, a panel operated bypass switch should be also wired, this would allow the pilot to operate the water pump via a separate circuit.

9. Installation Tips

- **Warning!** Ground test your new installation. Once you are certain the installation is working correctly, you may then proceed to flight test. Never flight test a newly modified engine without certainty of its operation.
- Do not run the water pump for extended periods of time without water flowing through it, i.e. don't run pump dry. The mechanical water seals in the pump must run fully submerged in water. If they run dry for too long they can be damaged and will start to leak water.
- We recommend a coolant mix of 50% water and 50% antifreeze (ethylene glycol). This gives a boiling temperature of 107 °C (225 °F). Increasing the percentage of antifreeze in your coolant mix will increase the boiling temperature, although it will degrade cooling performance after a short while. This is due to a build-up of solids from the antifreeze on the walls of the cooling core. If higher boiling performance is required we recommend using a waterless coolant such as [Evans NPG+ Waterless Coolant](#). Evans claim a boiling temperature of 190 °C (375 °F) allowing for maximum protection during high altitude flight.



Figure 9.1: [Evans NPG+ Waterless Coolant](#).

- Once the system is topped with coolant, with the engine off and stationary, remove the radiator cap and run the water pump. Periodically loosen, allow air to escape, then tighten each of the outlet banjo bolts to purge air from the system. It may be necessary to massage the piping while listening for air bubbles still contained in the lines. Continue until a solid

stream of liquid is observed. At the end of the installation, make sure all of the banjo bolts are fully tightened and do not allow coolant to leak from the system.

- One of the aluminum banjo bolts is drilled and tapped to accept a water temperature probe. This banjo bolt and probe can be located on any of the heads. Testing has shown us that all the heads will be at the same water temperature. This is one of the advantages of liquid cooling.